

# **USER'S MANUAL**

## Portable Slit Lamp



# CONTENTS

1. SAFETY CONSIDERATION.....	1
2. COMPONENTS OF THE PRODUCT.....	3
3. PRIOR PREPARATION.....	3
4. PREPARATION BEFORE USE.....	4
5. HOW TO USE.....	5
5.1. DIOPTRER ADJUSTMENT.....	5
5.2. PUPIL-DISTANCE ADJUSTMENT.....	5
5.3. ILLUMINATION CONTROL.....	5
5.4. FOCUSING.....	6
5.5. SLIT OPENING AND SHUTTING RING.....	6
5.6. ILLUMINATION ANGLE.....	6
5.7. FILTER.....	6
5.8. CHANGE OF MAGNIFICATION.....	6
5.9. CHANGE OF BATTERY.....	6
6. AFTER USE.....	7
7. DAILY MAINTENANCE.....	7
8. FOR SAFETY OPERARION.....	7
9. TECHNICAL SPECIFICATIONS.....	8
10. PACKING.....	9

# Preface

Dear Users:

Thank you and congratulations on your purchase of this Portable Slit Lamp. This user's manual provides a description of the operating procedure of this unit along with the important precautions to be observed during its use. Please read this manual carefully to assure that this instrument can demonstrate its full capabilities and used effectively. Please keep this manual in an easily accessible location near the instrument for future reference.

**Operational Precautions for safety and accident prevention in use of**

## Portable Slit Lamp Battery

**If any irregularity or fluid leakage should occur:**

- ★ Immediately move the battery further away from fire. Otherwise, leaked fluid or gas may catch fire and explode.
- ★ If battery fluid got into your eye, rinse it off with clean water and see your doctor at once.
- ★ If your body or clothes should be contaminated with batter fluid, wash it out.

**Recommended practice of battery disposal:**

A lithium ion battery can be recycled. If a power battery you have will not be used any longer, it is recommendable to cover its contacts with insulating tape (for instance, cellophane tape) before taking it to us.

**Operational Precautions**

- ★ The instrument should be installed and/or stored in a dust free place free from high temperatures, high humidity and direct sunlight. The environment conditions described below should be observed strictly:





	In Operation	In Storage
Environmental temperature	10°C to 40°C	-15°C to 60°C
Relative humidity	30% to 75%	10 to 95%





- ★ Be careful about where the instrument is to be installed, to keep it from accidentally being unplugged during operation. If it should be unplugged, be sure to turn off the power switch before plugging again.

# 1. SAFETY CONSIDERATION

Please read this User Manual thoroughly to ensure safe and correct use of the instrument.

★ General definitions of safety symbols are indicated below In the symbol for this operation manual and product, in order to use a product correctly, various symbols indication is given. Please read the text after understanding the following contents well.

Indication	Definition
	The word "WARNING" is intended to alert the user to extremely important instructions, procedures, or conditions which, if not correctly followed, could result in equipment failure personal injury or death.
	The word "CAUTION" is intended to alert the user to special instructions, procedures or conditions, which may cause personal injury or equipment failure.
	This symbol calls attention to an action that must be done.
	This symbol calls attention to an action that must not be done. The instruction for the prohibited act is associated with this symbol.

 <b>WARNING</b>	
	At no time attempt to remodel or disassemble this product. Damage to the product or personal injury will result.
	When this product breaks down, or when bad conditions arise, please inform a dealer immediately. It will become the causality of an accident if it continues using it in the condition of having broken down.
	When smoke comes out or the burning smell occurs, please extract a battery from a product immediately. When abnormalities, like there is a nasty smell during battery charge occur, please stop charging it and pull out a power supply plug from a plug socket.
	Do not short-circuit the polarities of the battery pack with a metal object such as wire.



When you do not use it for a long period of time, please pull out and keep a battery from product. Since product is in a standby state, very little current flows and a battery is exhausted.

Avoid storage or use of the product under the following conditions:



- 1) In an environment where the temperature falls below +10°C or exceeds +35°C.
- 2) Where noxious gases or pollutants are present.
- 3) High humidity environment.
- 4) Where water drop environment.
- 5) Where dust sand grit may occur.
- 6) Where there oil fumes or greasy substances are emitted.
- 7) Where there are atmospheric concentrations of salt.
- 8) Near gas generation areas and places where dust accumulates.
- 9) Do not expose to strong vibrations (areas of seismic activity) and sudden shocks (this includes transportation) etc.
- 10) A place with the tilt angle of do degrees or more.
- 11) The place exposed to direct sunlight.
- 12) The place exposed to the radiated electromagnetic field.



Please do not touch optical parts with a finger. It becomes the cause by which an observation image worsens.

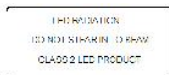

**LED RADIATION**  
Do not stare into beam Class 2 LED product.



Li-ion

Please discard lithium ion battery according to the regulations of a local self-governing body.

## 2. COMPONENTS OF THE PRODUCT

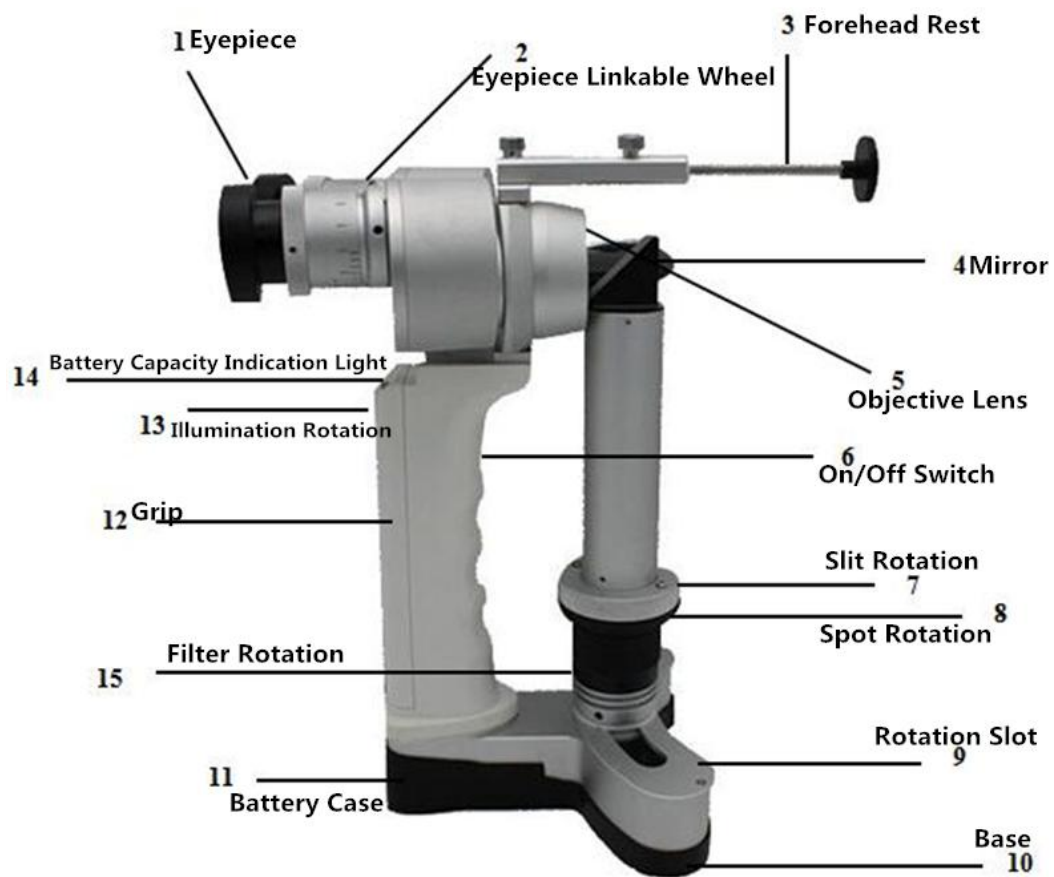

## 3. PRIOR PREPARATION

Please take out a main part, a diopter adjustment bar, a forehead rest, a battery, etc. From a carrying case. Next, please insert a battery in the main part battery accommodation section Firmly.



Unless it is inserted firmly, it may be unable to illuminate, or a battery may fall.

#### **CAUTION**

When the capacity of a battery is falling, using a battery charger, please charge beforehand and use. The charging time is about 2 hours. The CHARGE lamp will start to blink. Charging is complete when the CHARGE lamp continues to glow.

## **4. PREPARATION BEFORE USE**

- 1) The check of an eyepiece
- 2) Please check an eyepiece loosening in an eyepiece cylinder 10X, and being mounted in it that there is nothing.

It is correctly unobservable if eyepiece is loosening.

- 3) Please check that there is no dirt, such as a fingerprint, on the eyepiece surface.
- 4) In case of 10X eyepiece are used, please take out the 16X eyepiece from binocular before attaching the 10X eyepieces.



16X eyepiece

- 5) The check of illumination light
- 6) Please turn a slit opening-and-closing ring clockwise, and open a slit to the Maximum.



- 7) Please push a lighting ON/OFF switch. A round illumination light is seen.
- 8) Next, please check rotating a filter and being illuminated by Non-filter, green, blue and conversion filter for color temperature.

## 5 HOW TO USE

### 5.1. Diopter Adjustment

- 1) When the diopter is known, please carry out diopter adjustment with a diopter scale.
- 2) When you attach a diopter adjustment bar and you adjust a diopter, please adjust in the following procedures:
  - ① Please loosen and remove the attachment screw of a forehead support and attach a diopter adjustment bar.
  - ② Please turn ON illumination, and perform diopter adjustment of both of right and left so that you observe a diopter adjustment bar from an ocular and a focus matches. (The working distance is designed by about 80mm)



### 5.2. Pupil-distance adjustment

Please rotate the lens-barrel of the binocular section, and when you see an eyepiece part with both eyes, adjust the PD to become one image.

When not visible to one image, it is possible that the diopter adjustment can not be performed appropriately. In this case, please perform a diopter adjustment once again.



### **5.3. Illumination control**

A illumination ON/OFF switch is turned ON, illumination control volume is turned, and the quantity of illumination is adjusted.

If it turns to right-hand side, it will become bright, and it will become dark if it turns to left-hand side. In the maximum illumination, the illuminance without a filter is about 10,000 luxs.

◆ Turn on LED at the upper left of illumination control volume at the time of the illumination switch ON. In addition, when battery capacity has decreased, it blinks, and the light will be put out if it becomes less than 6V.

### **5.4. Focusing**

Apply the forehead rest to the patient's forehead, then loosen the clamping control while observing the eye with the eyepiece and move the slit lamp itself forward or backward to focus on the subject part.

◆ Since the forehead rest is executed with a spring, even if the slit lamp itself drawn forward, it will not leave the forehead of the patient easily.

### **5.5. Slit opening and shutting ring**

Turn the slit opening and closing ring to adjust the slit width. When turn this ring clockwise, slit open, and turn it counterclockwise, slit will be closed.

### **5.6. Illumination angle**

Hold the slide ring with fingers and move it right or left, illumination angle +/-30 degrees available.

### **5.7. Filter**

By rotating a filter, G(Green), B(Cobalt blue), O(conversion filter for color temperature), and those without a Non filter can be chosen as an illumination system. Please use properly according to the use of observation. A color temperature change filter serves as illumination near daylight color.

### **5.8. Change of Magnification**

Two magnifications available for this hand-held slit lamp by exchanging the eyepiece. Standard eyepiece 10X and 16X packed together with this instrument.

### **5.9. Change of Battery**

1) Battery

2) The first use and when you do not use it for a long time, please be sure to charge before using. About two hours charge at empty level.

(charge time is changed due to remaining power level)

4) The adapter for charge can be supplied from AC100 -240V power supply.

5) The CHARGE lamp will start to link during charge. Charging is complete when the CHARGE lamp continues go glow.



Battery and Charger

## 6 AFTER USE

1) After use should clean a main body and should keep it cleanly.

2) Please remove a battery, when you do not use it for a long period of time, and keep a product in the carrying case of exclusive use carefully.

3) When the display lamp of remaining battery level blinks, please remove a battery from main body and charge a battery.

## 7 DAILY MAINTENANCE

1) An eyepiece and objective lens cover glass

When clean off the surface of an eyepiece and/or objective lens cover glass, please use lens paper or soft cloth, if it has fingerprint or fatty oil, mist lens paper or soft cloth with alcohol to clean off.

2) Mirror

By viewing, the mirror for illumination of the illumination output section checks the existence of a crack.

Cleaning of dart, please use lens paper or soft cloth. If it has fingerprint or fatty oil, mist lens paper or soft cloth with alcohol to clean off.

3) Please check that the operation like each part is smooth. Please consult with a dealer, when fault is discovered in an operation.

## 8 FOR SAFETY OPERATION

1) After the completion of charge should remove a battery from a battery charger promptly.

Keep in mind the charge state of 2 hours or more that there is risk of overcharge.

2) About 300 charge or more is possible for a battery. The number of recharger is changed due to the remaining battery level. A battery life can be extended by charging,

after remaining battery level has decreased if possible.

## 9 TECHNICAL SPECIFICATIONS

<b>Microscope</b>	
Eyepiece	10X and 16X
Objective lens	1X
Total magnification	10X and 16X
Diopter adjustment	±5D
Pupil Distance	52~72mm
Working Distance	80mm
<b>Slit Illumination Part</b>	
Slit Width	0~10mm continuously adjustable
Slit Height	0.5mm, 3mm, 5mm, 10mm
Spot Diameter	0.5mm, 3mm, 5mm, 10mm
Slit Rotator Angle	Horizontal ±30°
Filters	Heat absorption, Grey, Red free, Cobalt blue
Illumination:	<b>White LED</b>
Working hours	5~6 hours
Voltage/ Frequency	AC 220V10%/ 50Hz1Hz AC 110V10%/ 60Hz1Hz
<b>General</b>	
Net weight	750G
Gross Weight	2.5KGS
Package	white and black Carrying Cases for choice
Packing size	410mm*195mm*230mm

## 10 PACKING

Portable Slit Lamp .....	1 set
Eyepiece 16X.....	1 set
Diopter adjustment bar .....	1 pc
Li-ion Battery.....	2 pcs
Battery charger.....	1 pc
Forehead rest .....	1 pc
Carrying case.....	1 set
User manual.....	1 pc

★ THE CONTENTS OF THIS USER MANUAL MAY BE CHANGED WITHOUT PRIOR NOTICE.