

Multifunctional Anesthesia Unit

USER'S MANUAL



Safety Guide

1.Thank you for selecting this Anesthesia Machine. You must carefully read and properly keep this User Manual for future reference before using the machine. This User Manual is of the version V11.2 and was issued in August 2012.

The terms in this User Manual are explained as follows:

Warning: this refers to the information you should know about how to avoid patients and medical staffs from injuries.

Caution: this refers to the information you should know about how to avoid the equipment from being damaged.

Attention: this refers to the important information that is emphasized.

2.This anesthesia machine must be operated by a professional anesthetist. Those other than professional anesthetist must not use this anesthesia machine.

3.To prevent sudden power supply accident from causing adverse impacts to the patient, you must properly connect the emergency battery to the anesthesia machine before use.

4.The AC power supply to the anesthesia machine must be properly grounded for protection.

5.This anesthesia machine is not explosion-proof and thus cannot be used in an environment with combustible, explosive anesthetic gas. This anesthesia machine is an ordinary device which is not splash-proof. If fluid is splashed to it, fluid must be immediately wiped off. Never let the fluid enter the interior of this anesthesia machine.

6.Before this anesthesia machine is put into use, the respiratory circuit and intubation tube of such machine must be thoroughly washed and disinfected.

7.Before this anesthesia machine is put into use, it should be ensured that such anesthesia machine is in good and complete performance condition and should never be caused to operate with faults.

8.To avoid danger of explosion, such inflammable anesthetics as diethyl ether, cyclopropane, etc must not be used on this anesthesia machine. This anesthesia machine only complies with relevant provisions of GB 9706.29 — 2006 and is an anesthesia machine on which only non-inflammable anesthetics can be used.

9.Anti-static or conductive breathing tubes cause combustion when a high-frequency electrical surgical device is being used, so it is not recommended to use such device.

10.The functions of this anesthesia machine will be adversely impacted by the nearby high-frequency surgical device or short-wave therapeutic equipment.

11.An independent ventilation means (such as a simple respirator with mask) can be available at any time when the anesthesia system is being used.

Figure & Type Matter

DANGER: Denotes that it should be alert to high danger.

WARNING: Denotes that it should be alert to moderate danger.

NOTE: Denotes that it should attend slight danger.



The Equipment of Type B.



Check the random file.



Through the CE Certificate.

Process Check List

Startup:

1. Please confirm that the power is connected, and then start up the machine.
2. Before use, check whether the tubes of the machine are correctly installed and the gas circuit leaks.
3. If the catheter contains water, remove water and then connect the catheter to the machine.
4. Connect the test lung and adjust the tidal volume according to the body weight of the patient.

When in use:

1. Remember to judge the operating status of the machine by the condition whether the air storage bag of the Air bellow operates.
2. Always pay attention to the inspiratory and expiratory valves; they should move freely when in use.
3. Please do not place the fluid container (such as disinfectant, various agents, etc) on the machine body; this is to prevent fluids from infiltrating into the machine.

After use:

1. Shut down the machine and then cut off the power.
2. Separate the screwed pipe from the machine.
3. Disinfect the machine according to the User Manual.

Note: please do not have the machine collide with other objects during handling; do not twist the tubes.

CONTENTS

1.Overview	1
2.Structural Characteristics and Operating Principles	2
3.Technical	7
4.Dimensions and Weight	10
5.Installation and Commissioning	10
6.Use and Operation	17
7 Routine Maintenance	31
8 Troubleshooting	33
9 Safety and Accident Handling	36
10 Packaging, Transportation and Storage	37
11 Others	38

1.Overview

This Anesthesia Machine is an essential important anesthesia device in an operation room. Its function is to provide oxygen and anesthetic agent to a patient needing to go through an anesthesia operation and perform ventilation management.

This anesthesia machine is intended for use in children and adults with a body weight heavier than 10kg.

This Anesthesia Machine is equipped with an accurate dedicated anaesthetic vaporizer and a safety device for preventing cyanosis and necessary alarm system. During the anesthesia, the patient's respiratory functions can be managed by using a microcomputer controlled pneumatic electrically controlled synchronizing anesthesia respirator. Each connection part of the whole machine is a standard interface. A highly efficient and large volume soda lime absorber can minimize the re-inhalation of carbon dioxide by the patient.

Operating conditions for Anesthesia Machine:

-----Ambient temperature: 10 ~ 40 °C ;

-----Relative humidity: no higher than 80 %;

-----Atmospheric pressure: 860 hPa ~ 1060 hPa.

-----Power requirement: ~220—240V, 50/60Hz, 40VA, to be well grounded.

-----Air source requirement: medical oxygen and laughing gas with a rated pressure ranging from 0.3 to 0.5MPa.

Attention: the AC power supply used for the anesthesia machine must be well grounded.

Attention: the anesthesia machine used must be equipped with a carbon dioxide monitor complying with ISO 9918 : 1993, an oxygen monitor complying with ISO 7767 : 1997 and an expiratory gas volume monitor complying with 51.101.4.2 of Medical Electrical Equipment Part II: Special Requirements for Safety and Basic Performance of Anesthesia System.

2. Structural Characteristics and Operating Principles

This anesthesia machine consists of a main unit, an anesthetic vaporizer, a flow meter, an anesthesia respirator and a respiratory circuit system.

2.1 Anesthesia Machine Main Unit

The structure and operating principles of the main unit are as shown in Figure 1.

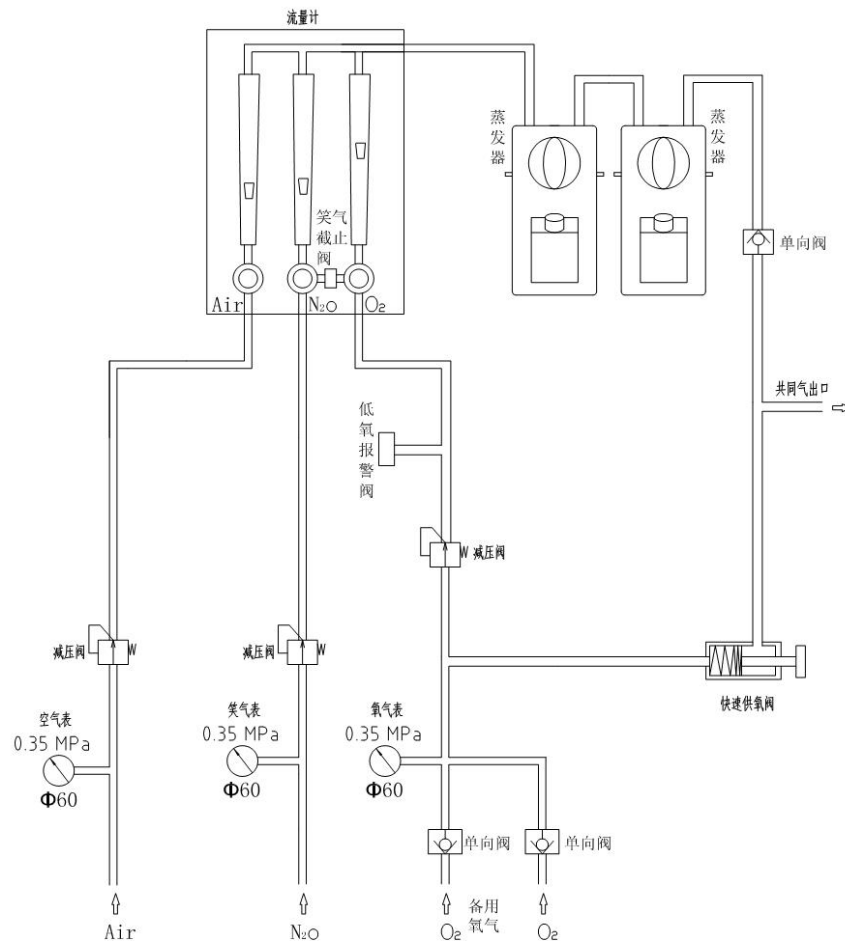

Figure 1

The flow meter not only can indicate but also can adjust the flow rates of the oxygen and

nitrous oxide. A “oxygen-nitrous oxide linkage device” and “nitrous oxide cut-off equipment” are installed between the oxygen flow regulator valve and laughing gas flow regulator valve. Their functions: when only the oxygen flow regulator valve is opened, laughing gas flow may be closed; but if the laughing gas flow regulator valve is opened, the oxygen flow regulator valve will inevitably be opened by the link mechanism to ensure the oxygen concentration required by the patient. After the oxygen and laughing flows are opened, the oxygen flow rate will decrease if the oxygen flow rate is decreased gradually. When the pressure of the oxygen entering the flow meter is lower than $0.20\text{MPa}\pm 0.05\text{MPa}$, the flow meter will automatically close the laughing gas flow. At the flow meter outlet, oxygen and laughing gas are mixed with each other and then enter the anesthetic vaporizer.

If the anesthesia machine is equipped with two vaporizers and such two vaporizers are connected in series, when one vaporizer is activated the other one cannot be activated and this can ensure that only one vaporizer can work at any time to ensure patient safety. The mixed gas flowing out from the anesthetic vaporizer flows through a one-way valve to the gas outlet. Then it passes through a transition interface to enter the recirculation circuit to be described later in this manual.

When the anesthesia machine is in operation, the pressure at the gas output port will be caused to be always at a fluctuating level by turning on the rapid switch. The one-way valve isolates the adverse impacts that such fluctuating pressure has on the vaporizer.

2.2 Anesthetic Recirculation Circuit

The anesthetic recirculation circuit, also called patient circuit, is a combination gas circuit device connected with the patient. Its main function is to transmit mixed anesthetic gases to the patient and allow the patient to normally inhale oxygen and exhale carbon dioxide through such system. It can operate in the “Maneuvering” or “Manual” mode. The so-called “Maneuvering Mode” refers to the mode in which the patient’s respiratory function is managed by using the anesthetic respirator. The so-called “Manual” mode refers to the mode in which an anesthetist controls the respiration of the patient by

pressing the air storage bag connected on the recirculation circuit.

An integrated anesthetic recirculation circuit is used on the Anesthesia Machine.

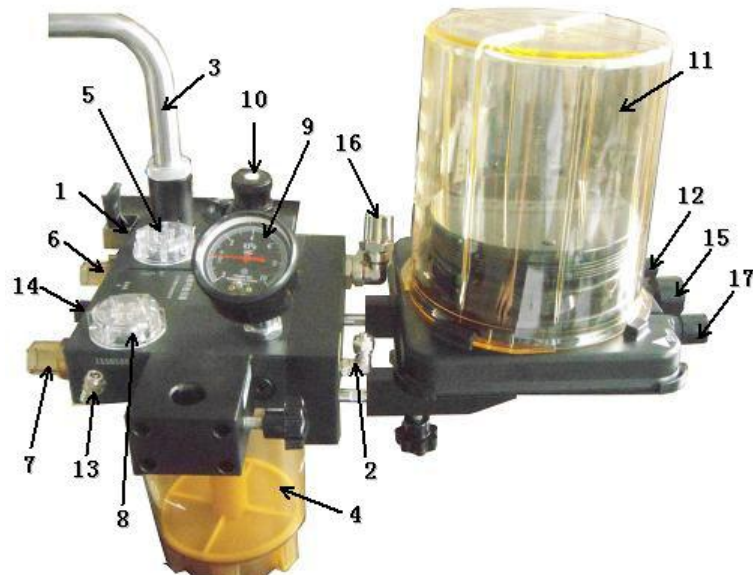

Figure 2

1. Manual/Maneuvering changeover valve
2. Common gas inlet
3. Gas storage bag connection port
4. Carbon dioxide absorber
5. Exhalation valve
6. Exhalation screwed pipe port
7. Inhalation screwed pipe port
8. Inhalation valve
9. Pressure gauge
10. APL safety valve
11. Air bellow
12. Driving gas inlet
13. Pressure signal
14. Oxygen concentration sensor interface
15. Waste gas exhaust port
16. Connection with 17 through screwed pipe
17. Connection with 16 through screwed pipe

When the Manual/Maneuvering changeover valve is put to the Manual position, the recirculation circuit is in the “Manual” operating mode. By pressing the rapid oxygen supply valve on the main unit, the oxygen is enabled to directly enter the gas storage bag connected with the recirculation circuit through the common gas inlet.



Figure 3

When the Manual/Maneuvering changeover valve is put to the Maneuvering mode, the recirculation circuit is in the “Maneuvering” operating mode. At this time, the air bellow replaces the gas storage bag in the “Manual” mode. The driving gas from the anesthetic respirator enters the air bellow through the driving gas inlet on the recirculation circuit and forms a driving force on the exterior of the folded bag of the air bellow to replace the “Manual” mode.



Figure 4

As the gases inhaled by the patient not only contain the gas from the air bellow bag but also are accompanied with fresh mixed gases from the main unit of the anesthesia machine, the gas expired by the patient is more than the gas in the air bellow bag in the amount. An automatic adjustment device is installed in the air bellow bag and it will discharge the excessive gas.

During the operation, the flow rate of the gas output by the anesthetic respirator can be

obtained from the RPM of the flow rate sensing impeller between the expiration valve and expiration screwed tube. When the oxygen concentration needs to be monitored, the oxygen concentration can be sampled at the oxygen concentration transducer connector. The carbon dioxide monitor is connected at the expiration screwed tube connector of the anesthetic recirculation circuit. The anesthetic gas monitor is connected at the common gas inlet of the anesthetic recirculation circuit.

Attention: latex components within this system include the screwed tube, gas storage bag and mask. When washing and disinfecting them, the user should note that the screwed tube consists of disposable components and reusable components. The gas storage bag is a reusable component. When washing and disinfecting latex components, special attention should be paid to that cleaning agent or disinfectant may have corrosive and damaging effects on the components. These several latex components are mainly in the anesthetic ventilation system. The reusable gas storage bag should be reused to the extent that it is not damaged.

2.3 Anesthetic Respirator

The anesthetic respirator uses a pneumatic electric controlled anesthetic respirator.

The medical compressed oxygen from a power gas output passes through a gas jetter with venture effect to form a gas in which medical oxygen is mixed with atmosphere at a certain pressure. Such mixed gas is delivered into the ventilation circuit of the anesthesia machine to drive the motion of the air bellow bag and thus perform the mechanical ventilation of the patient.

In the anesthetic respirator, a fast solenoid valve, a high sensitivity flow sensor and pressure sensor and single-chip computer control system are used to set, measure and adjust the ventilation pressure, ventilation duration, ventilation volume, etc applied to the patient. When the anesthetic agent takes effect and the patient loses spontaneous breathing, the anesthetic respirator will perform mechanical ventilation at the set frequency, respiratory rate and tidal volume. When the operation is completed and spontaneous breathing of the patient is resumed somewhat, the anesthetic respirator will

automatically synchronize with the spontaneous breathing of the patient.

If the anesthetic circuit is in the “Manual” mode, the anesthetic respirator can display the tidal volume, ventilation frequency and airway pressure in real time although it does not participate in the ventilation control.

2.4 Anesthetic Vaporizer

 **Attention: when the vaporizer does not match the anesthesia machine, the performance of the vaporizer will be deteriorated.**

A bypass variable, outside-circuit dedicated vaporizer is used on the anesthesia machine. This vaporizer has good pressure compensation and temperature compensation functions. When it is in the off mode, its inlet is directly communicated with its outlet so that the fresh gas does not pass through the vaporizer chamber at all to avoid the leakage of the anesthetic agent. After the vaporizer is opened by turning the concentration adjustment disk, the fresh gas passes through the switching valve to be split by a bypass temperature control needle valve; one flow carries the anesthetic agent vapor to pass through the control needle valve and arrive at the vaporizer outlet after being compensated by the pressure compensator and entering the vaporizer chamber; then it merges with the other gas flow directly from the fresh gas inlet. Turning the concentration adjustment disk can adjust the caliber of the control needle valve and this results in the adjustment of the concentration of the anesthetic gas in the mixed gas. The pressure compensator here is intended for preventing the impacts that the pressure fluctuation between the upstream and downstream of the vaporizer. The ventilation interval of the bypass needle valve automatically changes with the temperature to play the role of temperature compensation.

3 Technical

3.1 Operating mode: circulatory closed, semi-closed and semi-open.

3.2 Gas requirement: medical oxygen and nitrous oxide with a pressure ranging from 0.3 MPa to 0.5 MPa.

3.3 The maximum error of the pressure testing device should not exceed \pm (4% of the full scale reading + 8% of the actual reading).

3.4 For oxygen and nitrous oxide, a special pressure regulator with a safety valve will be provided. The exhaust pressure of the safety valve should not be higher than 6 kPa.

3.5 Indication range of the oxygen, nitrous oxide and air flow meter: 0.1 L/min ~ 10 L/min.

3.6 The flow meter is equipped with an oxygen-nitrous oxide proportional control device.

When the oxygen concentration in the mixed gas N_2O/O_2 conveyed by the anesthesia machine is no lower than 21%

3.7 Oxygen Flush: 25~75 L/Min;

3.8 Anesthetic gas concentration adjustment range of vaporizer: 0 ~ 5%, relative error \pm 20 %.

3.9 Anesthesia ventilator

3.9.1 Respiration Mode: IPPV, SIPPV, VCV, PCV, IMV, SIMV, PEEP, Manu, Sigh and so on.

3.9.2 Respiration Frequency: 0~100bpm

3.9.3 IMV frequency: 1~12bpm

3.9.4 I/E Ratio: 8:1~1:10

3.9.5 Tidal Volume: 0~1500mL

3.9.6 Ptr: -10~10 hPa;

3.9.7 Controlled ventilation and assisted ventilation switching time: 6s

3.9.8 Inspiratory Plateau: 0~1S;

3.9.9 PEEP: 1.5~10 hPa;

3.9.10 O₂ Concentration: 21%~100%

3.9.11 Sigh: one deep breath per 80 controlled respirations, the inspiration time is 1.5 times of the setting point and the permissible error is -10% or 15%.

3.9.12 Maximum safety pressure: \leq 12.5 kPa.

3.9.13 Pressure limit range: 1~6 kPa

3.9.14 Airway pressure alarm: adjustment range of upper alarm limit: 0.3kPa ~ 6 kPa, permissible error \pm 0.2 kPa, or \pm 15% (whichever is greater), the machine should immediately raise a high level alarm when the airway pressure rises to the alarm value;

the lower alarm limit ranges from 0.2 to 5 kPa and the permissible error is ± 0.2 kPa or $\pm 15\%$ (whichever is greater). The machine should immediately raise a medium level alarm when the airway pressure drops to the alarm value and such condition lasts 4 to 15s.

3.9.15 Tidal volume alarm: the upper alarm limit ranges from 50 to 2000ml, the permissible error is $\pm 20\%$, the adjustment range of the lower alarm limit is 0~1800ml, the permissible error is $\pm 20\%$ and the machine should raise a medium level alarm.

3.9.16 Oxygen concentration alarm limit: upper alarm limit adjustment range is 21%~100%, the permissible error is $\pm 3\%$, the adjustment range of the lower alarm limit is 10%~80% and the permissible error is $\pm 3\%$.

3.9.17 When the airway pressure continues to be higher than 15 hPa ± 1 hPa for 15s ± 1 s, then the machine will raise an audible alarm, the pressure will be displayed in red and the continuous high pressure red alarm wording is displayed on the screen of the anesthetic respirator.

3.9.18 Power supply alarm: A. when the voltage of the grid power supply to the anesthesia machine is lower than AC190V ± 5 V, the machine raises an alarm sound and the low grid power voltage yellow alarm is displayed on the screen of the anesthetic respirator. B. when the voltage of the lead-acid battery is lower than DC10V ± 1 V, the machine will raise an audible alarm and the low battery yellow alarm is displayed on the screen of the anesthetic respirator. C. when AC power supply and battery power supply both fail, the anesthesia machine will immediately raise an audible alarm and the alarm last more than 120s.

3.9.19 Battery operation prompt: the emergency battery is a lead-acid battery with a rated output voltage of DC 12V. The battery with sufficient power can power the anesthetic respirator to continuously work for more than 30min. When the respiratory operates on a battery with sufficient power, the anesthesia machine will emit a 30s long-lasting sound prompt. Pressing and holding the shuttle key for 2s can enable you to view the voltage of the current battery at the lower right corner.

3.9.20 The respirator monitoring parameters include tidal volume, ventilation volume, airway pressure, oxygen concentration, total respiratory frequency, spontaneous inspiration rate, airway resistance, lung compliance and system power.

3.9.21 The anesthetic respirator can detect a minimum tidal volume of 50mL with a resolution of 10mL.

3.9.22 The operator can view the causes to the conditions for the last alarm at the lower left corner of the screen.

3.9.23 All displayed measurements are those in the standard status (STPD) condition.

3.9.24 All upper and lower alarm limits are default settings when the machine leaves the factory. The user can reset the limits according to the requirement.

4 Dimensions and Weight

Dimensions: 1580 mm×500 mm×850 mm

Weight: 75 kg.

5 Installation and Commissioning

Attention: installation, commissioning, inspection and use of the anesthesia machine should be completed by qualified professionals. This anesthesia machine has been commissioned by a professional when delivered for use. The user does not need to adjust it; otherwise it will cause unexpected fault or damage.

5.1 Preparations Prior to Installation

1) You should confirm that the anesthesia machine and its fittings are complete and free from damage in the transportation, contents of the packaging box are consistent with the packing list. Keep properly the packaging box and vibration proof liner in the box for use in another transportation.

Attention: if it is found that the anesthesia machine is damaged in the transportation, this should be notified immediately to the carrier and claims should be made for compensation. If contents of the packaging

box are found inconsistent with the packing list, please immediately notify the manufacturer or authorized agency of a certain company.

2) Carefully read this User Manual by comparing to this anesthesia machine to get familiar with the operating principles, structural characteristics and control panel of the anesthetic respirator.

3) Check the medical compressed oxygen source and laughing gas source and confirm that their pressure ranges from 0.3 to 0.5MPa. If they are supplied with a cylinder, check and confirm that the gas in the cylinder is sufficient, that the reducer on the gas storage cylinder is in good performance and correctly installed.

4) Check the single-phase AC power supply used for the anesthesia machine and confirm that the voltage of the power supply ranges from AC 220 to 240V and the power supply is well grounded. Confirm that the emergency battery of the anesthetic machine is correctly connected.

5.2 Installation of Anesthesia Machine

1) Install four casters on the frame of the anesthesia machine. The two casters installed on the front of the anesthesia machine should be equipped with a locking device. The two casters without a locking device should be installed on the back of the anesthesia machine.

2) Push the frame of the anesthesia machine to the pre-determined position and then depress the locking device for the front caster to disable the anesthesia machine to freely move.

3) Install the anesthetic agent vaporizer onto the special frame of the vaporizer on the anesthesia machine and tighten the fastening screw rod on the connection base by using an Allen tool.

4) Fix the anesthetic recirculation circuit on the support frame on the left side of the anesthesia machine through a branch arm and then connect the respiratory bellow and gas bag on the recirculation circuit.

5) Installing carbon dioxide absorber;

A) Prior to the use of the anesthesia machine, an appropriate amount of soda lime

needs to be loaded into the cup. Make sure not to exceed the max scale line. Then seal the cup and cup cap following the method as below; first pay attention to the engagement position between the cup cap and cup and the cup cap has been fixed on the circuit body.

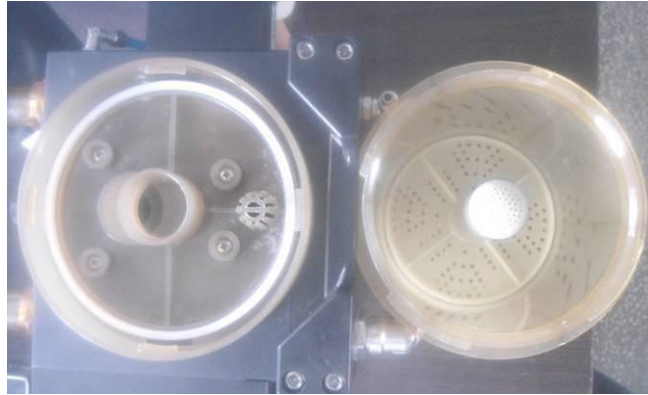

Figure 6

B) Observe the buckle position of the cup cap (a total of 4 buckle positions)



Figure 7

C) Observe the snap position of the cup (a total of 4 snaps)

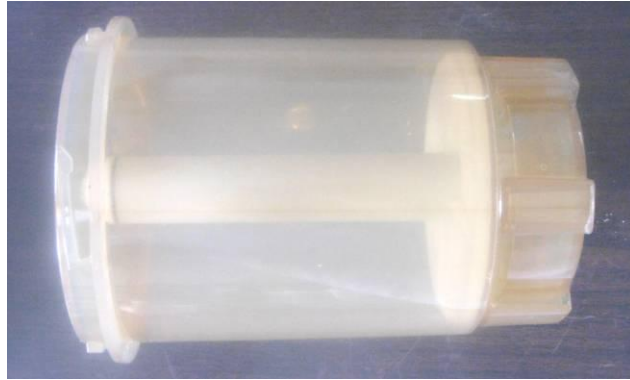

Figure 8

D) Align the snap of the cup with the buckle position of the cup cap, turn the cup right by grasping the cup with two hands (pay attention to the locking direction) until the snap is in the inner most position of the buckle when you can hear a clicking sound. This indicates that the soda lime cup is sealed.

E) If soda lime needs to be replaced, turn the cup left when removing the cup (pay attention to the lock loosening direction). When you hear a clicking sound and then observe that the snap is completely separated from the buckle, you can remove the cup and then dump soda lime out from the cup. Perform operations again following the above mentioned steps.



Figure 9

F) Connect the emergency battery and connect the anesthetic respirator to the

anesthetic recirculation circuit by using a screwed tube.

G) Connect two screwed tubes on a Y-shaped tee tube. Connect one tube to the inspiration valve screwed tube connector of the recirculation circuit and connect the other tube to the expiration valve screwed tube connector of the recirculation circuit.

H) Connect the Y-shaped tee tube with the test lung or leather bag.

I) Connect the anesthesia machine to the compressed oxygen source and compressed laughing gas source by using a high pressure gas tube.

 Attention: the oxygen tube is blue 5×8 mm and the laughing gas tube is orange 5×8 mm.

J) Insert the power plug of the anesthesia machine into a single-phase AC 220V power outlet which is well grounded.

 Attention: the equipment should not be imbalanced when it is inclined by 10 DEG under horizontal condition and normal configuration, but addition of other device on the equipment decrease the equipment stability.

5.3 Pre-adjustment of Anesthesia Machine

1) Check the indication zero points on the pressure gauge on the recirculation circuit of the anesthesia machine and airway pressure gauge of the anesthesia machine. In case of any deviation, the zeroing screw of the pressure gauge needs to be adjusted by using a screwdriver.

2) Observe the output pressure gauge on the compressed gas cylinder or central gas supply system; its indication should range from 0.3 to 0.50MPa. After compressed oxygen and compressed laughing gas are connected, observe the indication of the power gas output pressure gauge; the indication should be consistent with the input pressure of the compressed oxygen; observe the oxygen pressure gauge and laughing gas pressure gauge on the anesthesia machine panel; their indications should be around 0.30 MPa (the pressure of the laughing gas should be 0.25 MPa and the oxygen

pressure should be 0.30MPa).

3) Turn the knob of the flow regulation valve on the flow meter and you should be able to see that: during the regulation the flow meter buoyant moves flexibly and the flow meter buoyant is stabilized and does not move upon completion of regulation.

4) Put the Manual/Maneuvering changeover switch to the manual position, plug the outlet of the Y-shaped Tee tube, press the rapid oxygen supply valve, the respiratory bag with a capacity of 3L should be filled full within 3 to 5s and the pressure gauge on the recirculation circuit should correspondingly indicate the pressure of the gas circuit.

5) Switch the anesthesia machine to the Maneuvering mode, connect the power of the respirator and set its operating parameters to the following values: tidal volume 0.70 L, ventilation frequency 20t/min, and respiratory ratio 1 : 2. You should observe that the test lung or gas storage bag inflates and deflates at the ventilation frequency of the respirator and the inhalation valve and expiration valve on the recirculation circuit operate freely.

5.4 Acceptance Test After Installation and Adjustment

1) Sealing Performance Test of High-pressure Circuit of Anesthesia Machine

Close the flow regulation valve on the flow meter, connect the compressed gas source and you can see on the anesthesia machine that the indications on the oxygen pressure gauge and laughing gas pressure gauge are around 0.3MPa. Then shut off the compressed gas source and you should observe that the indication from the pressure gauge on the anesthesia machine does not fluctuate obviously within five minutes.

2) Sealing Performance Test of Low-pressure Circuit of Anesthesia Machine

Put the Manual/Maneuvering changeover switch on the anesthetic recirculation circuit to the manual position. Plug the outlet of the Tee tube communicated with the anesthesia machine, supply gas with a rapid oxygen supply valve and you should observe that the gas bag inflates due to the charge; stop gas supply when the indication on the airway pressure gauge reaches 3kPa, and you should observe that the drop in the indication on the airway pressure gauge should be less than 0.4kPa within one minute.

3)Oxygen-Laughing Gas Linkage Function Test of Flow Meter

Connect the compressed gas source and connect the outlet of the anesthesia machine with the atmosphere. Turn the flow regulation valve on the flow meter. You should be able to observe that: when you just open the oxygen flow regulation valve the laughing gas flow is off; when you just open the laughing gas flow regulation valve the oxygen flow will be also turned on through a linkage mechanism; after the oxygen and laughing gas flows are fully opened, gradually reduce the oxygen flow rate and the laughing flow rate also decreases to the closed status gradually. Under normal ventilation condition, the flow rate should be stable and the flow rate of oxygen to laughing gas should be 1:1.5.

4)Test on Automatic Laughing Gas Throttling and Oxygen Supply Fault Alarm

Connect the compressed gas source, connect the outlet of the anesthesia machine with the atmosphere, open the oxygen flow regulation valve and laughing gas flow regulation valve, gradually decrease the pressure of the compressed oxygen conveyed into the anesthesia machine, observe the oxygen pressure gauge of the anesthesia machine, the laughing gas flow rate decreases with the drop in the pressure of the oxygen; when the oxygen pressure is lower than $0.20\text{MPa}\pm 0.05\text{MPa}$, the laughing gas flow is completely shut off and the anesthesia machine emits alarm buzz lasting no shorter than 7s.

5)Tidal Volume Test

Close the oxygen flow regulation valve and laughing gas flow regulation valve on the flow meter of the anesthesia machine, set the ventilation frequency of the anesthetic respirator to 20t/min and respiratory ratio to 1:2, turn the tidal volume regulation valve of the anesthetic respirator and you should be able to observe that the indicated value of the tidal volume after three to four ventilations tends to be stable and its adjustment range is no less than 50mL to 1500mL. If a test lung is used, you should also observe that the maximum error of the indicated value of the tidal volume of the anesthetic respirator compared to that of the test lung after stabilization does not exceed 20%.

6)Alarm Function Test

Test condition: close the oxygen flow regulation valve and laughing gas flow regulation valve on the flow meter of the anesthesia machine and set the operating parameters of the anesthetic respirator to the following values: ventilation frequency 20t/min and

respiratory ratio 1:2.

Attention: the ventilator alarm system is started up 120s after the startup of the ventilator.

7)Extension Function Test Upon Power Failure

Remove the AC power plug of the anesthesia machine (not open the power switch) and the anesthesia machine should continue to operate on the emergency battery.

6 Use and Operation

6.1Preparation and Inspection Before Use

1.Gas source check: check whether the oxygen and laughing gas in the cylinder are sufficient, whether the output pressure of the cylinder or hospital central gas supply system ranges from 0.3MPa to 0.5MPa and whether the connection circuit from the compressed gas source to the anesthesia machine is correct in good and completion condition.

2.Power check: check whether the grid voltage ranges from AC220 to AC240V, whether protective grounding is in good and complete condition and whether the power plug of the anesthesia machine is securely connected.

3.Check the use records and cleaning and disinfection records of the anesthesia machine (including the anesthetic respirator) and confirm that the performance of the machine is good.

 **Warning: never allow the anesthesia machine which is not thoroughly washed and disinfected or has potential safety threat to operate.**

4.Carbon dioxide absorber check: remove old soda lime in the absorber, wipe clean the interior of the absorber and fully charge the absorber with fresh soda lime.

5.Fill the anesthetic vaporizer with anesthetic agent.

6.Simulate the method for ventilation of the patient to repeatedly charge the recirculation circuit with gas by using the rapid oxygen supply valve and rinse the recirculation circuit

and ventilation circuit to remove the waste gases by using pure oxygen.

7. Adjust and set the parameters of the anesthetic respirator.

6.2 Use of Anesthesia Machine

1) The most critical operation to use the anesthesia machine is the feeding of the anesthetic concentration and ventilation management and control. The anesthesia machine can manage the breathing in the patient in the manual mode or automatically control the breathing in the patient following the set parameters. During the use, you should pay close attention to the condition whether the indications on all instruments on the anesthesia machine and anesthetic respirator meet the needs of the patient. Generally, indications from the instruments can only be used as reference even though they are very accurate and the patient's condition is the most fundamental basis.

2) Method for opening the anesthetic vaporizer: press the concentration adjustment disk and turn it counterclockwise to increase the concentration of the output anesthetic agent. After the adjustment disk turns, you do not need to press it with pressure.

Attention: only under the condition that the flow through the vaporizer ranges from 0.5 to 10 L / min and the output anesthetic agent concentration ranges from 0.5 to 5 vol% can the output concentration of the vaporizer be ensured to be within the permissible error range. It is prohibited to use the vaporizer within the range from the "OFF"(or "0") graduation to the first graduation line because it cannot be ensured that the output concentration of the vaporizer is within the permissible error range.

3) Estimation of anesthetic agent dosage:

$$\text{Anesthetic agent dosage (mL)} \approx \text{anesthetic agent concentration output by the vaporizer (Vol\%)} \times \text{fresh gas flow (L/min)} \times \text{anesthesia time (hour)} \times 3$$

This formula is an empirical formula. For example, assuming that the set output concentration of the vaporizer is 1.5 Vol%, the sum of the oxygen flow rate and laughing gas flow rate read from the flow meter of the anesthesia machine is 2 L/min and the operation duration is estimated to be 8 hours, then the dosage of the anesthetic agent to

be prepared in the vaporizer must not be less than: $1.5 \times 2 \times 8 \times 3 = 72$ (mL) .

Of course, for safety and reliability, the dosage of the anesthetic agent to be actually prepared will be more than the estimation.

4)The anesthetic agent should be dosed to the 135mL between the highest and lowest graduation lines.

5)Due to the impact of the on-off actions, the vaporizer cannot be calibrated within the range from the “OFF” position to the “0” position, and so the concentration value cannot be set within such range.

6) During weaning, you should turn off the vaporizer by using the this method: press the concentration adjustment disk, clockwise turn the concentration adjustment disk to the zero point, you must see that the concentration adjustment disk snaps out and at this time you should determine that the concentration adjustment disk is locked.

7) During the ventilation with the anesthetic respirator, a flow rate higher than 2L/min is recommended. During manual recirculation closed anesthesia, an oxygen flow rate ranging from 0.7 to 1L/min is recommended to ensure the oxygen inhalation and life supporting needs of the patient.

8) The main role of the low oxygen alarm device and laughing gas shut-off device is to automatically raise an alarm and shut off the laughing gas flow when the medical oxygen pressure drops and medical oxygen cannot be normally used.

6.3 Use of Anesthetic Respirator

6.3.1Anesthetic Respirator

6.3.1.1 Turn on the power of the anesthetic respirator and the image on the screen is as shown in the figure below:

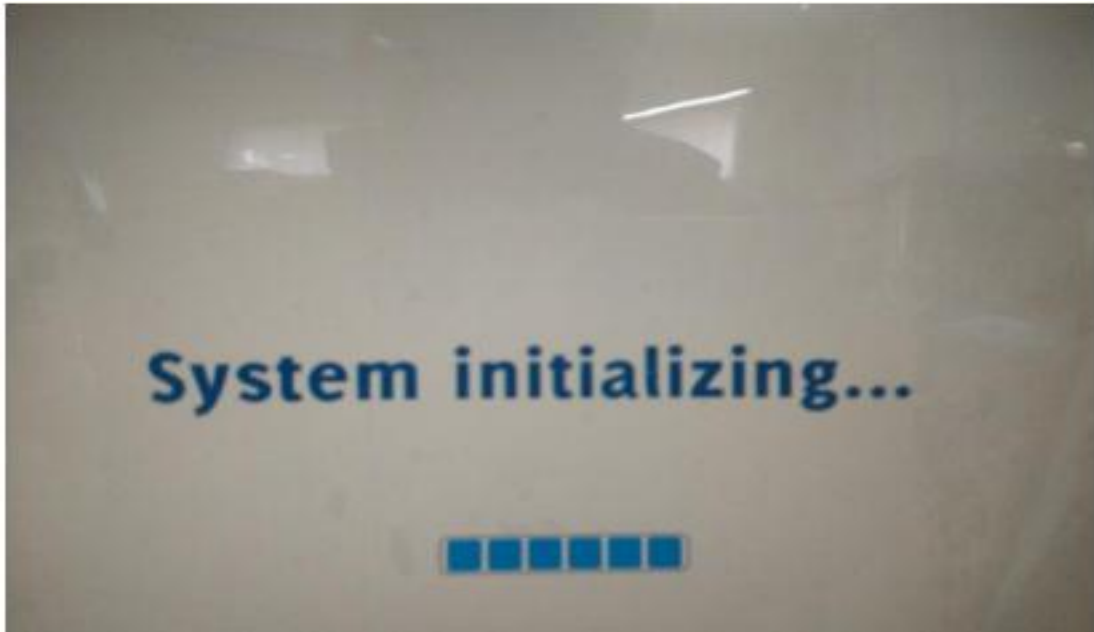

Figure 10

When the system enters the self check interface after the progress bar is 100% indication and the pressure sensor and oxygen concentration sensor are normal, the system automatically enters the interface 5s later. If it fails to enter the interface, the corresponding option will be shown in the red background and marked with “x” and the system cannot enter the interface. At this time, please check hardware to eliminate faults. If you need to forcedly enter the interface, press and hold the “Mode” key or the “Set” button for 5s to respectively enter the operating interface or calibration interface (it is recommended that operations on the calibration interface should be performed by the manufacturer’s after-sales service personnel).

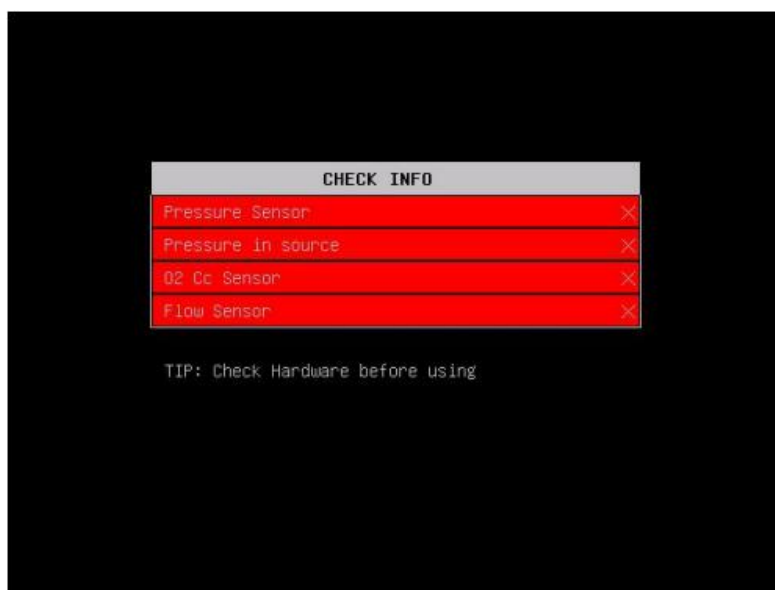

Figure 11

On this interface, rotating the shuttle in the horizontal direction can adjust the body weight value ranging from 0 to 150kg. Upon completion of setting the desired body weight, press the OK key to enter the operating interface. On this interface, if you do not operate the shuttle key the system automatically enters the operating interface 5s later.



Figure 12

The anesthesia machine enters the operation status and the image on the screen (Operating Interface 1) is as shown in the figure below:

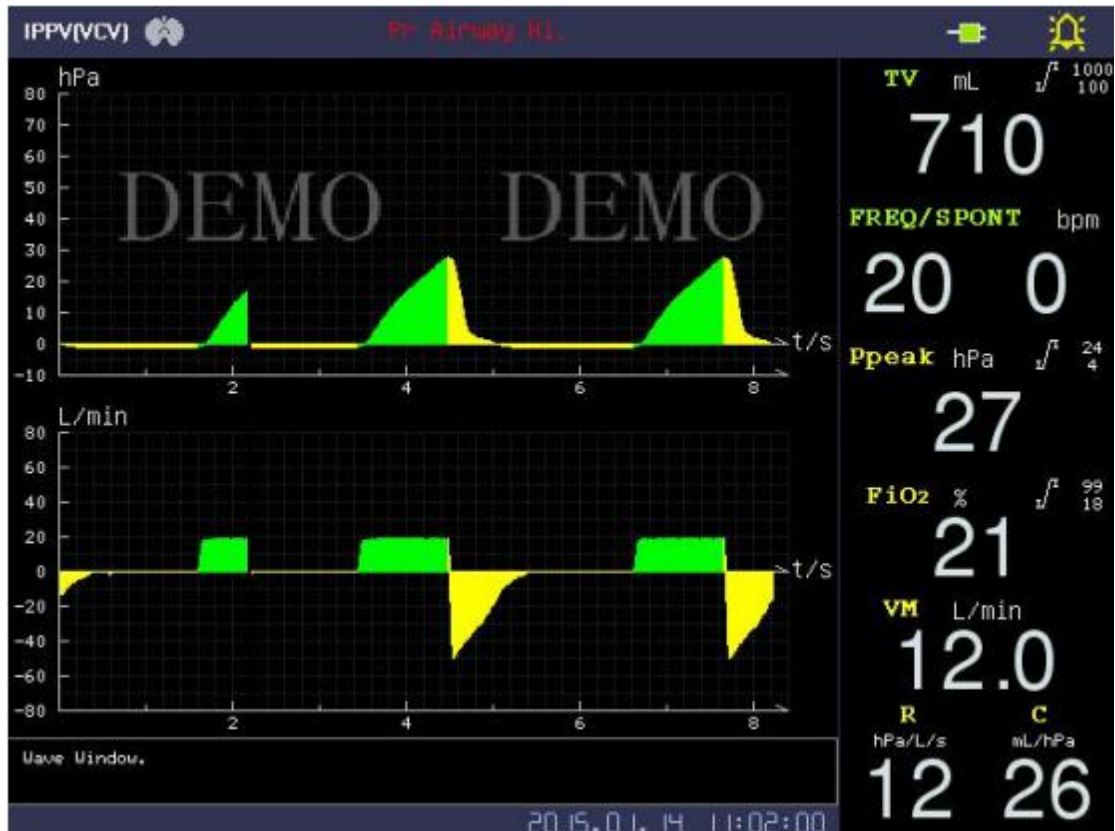

Figure 13

The indications in the Parameter Area 1 (blue area block) on the operating interface 1 include:

Tidal volume: this refers to the expiratory tidal volume tested.

Frequency: this refers to the total respiratory rate and in the IPPV mode it is the mechanical control frequency.

Spontaneous inspiratory frequency: this refers to the frequency of breathing initiated spontaneously by the patient which is detected by the anesthetic respirator within 1min.

Peak pressure value: this refers to the maximum pressure in the airway in each breath cycle.

Oxygen concentration: concentration of oxygen in the gas delivered by the anesthesia machine to the patient.

Ventilation volume: this refers to the accumulative sum of tidal volumes within each minute

Airway resistance: pressure difference generated per unit of flow rate in the airway.

Lung compliance: this refers to the change in the lung volume which is caused

when unit pressure changes.

The power AC or DC status, battery power status and loudspeaker status are displayed in Parameter Area 2 (red block).

The alarm status is displayed in the Parameter Area 3 (yellow block). A high level alarm is displayed in red, a medium level alarm is displayed in yellow and at the same time of alarm the alarm parameter information will be prompted to the user in a scrolling indication manner.

The current mode status is displayed in Parameter Area 4 (orange block).

Operation prompt instructions are displayed in Parameter Area 5 (purple block).

Real-time pressure waveform is displayed in Parameter Area 6 (green block).

Real-time waveform is displayed in Parameter Area 7 (brown block).

On Operating Interface 1, press the “Lung Loop” button and the system will switch to Operating Interface 2 and the displayed Parameter Area 7 (brown block) transforms from real-time waveform to the lung loop status.



Figure 14

6.3.1.2 Flow-volume loop: namely the Flow-V curve, the time integral of the flow rate is

volume. The flow-volume curve is a closed loop in the expiratory and inspiratory phases and is so called flow-volume loop.

6.3.1.3 Pressure-volume loop: namely the Paw-V loop, the time integral of the pressure is volume and the pressure-volume curve is a closed loop in the expiratory and inspiratory phases and is so called pressure-volume loop.

6.3.1.4 Instructions for Operation on the Setup Interface

On the operating interface, press the “Setup” button and Setup Interface 1 will pop up.

Operation method for setup interface: select the shuttle cursor to the option needing to be set, press the shuttle key, and the corresponding option is displayed in the inverse colored manner. Select and confirm the corresponding value, and then press the shuttle key again to complete the modification of the corresponding parameter.

All parameters will be loaded as default values during the first operation.

In different modes, the same parameter will be in grey or transformed. If the parameter is incorrect and this affects the interlock conditions, the parameter not meeting the interlock conditions will be displayed in red and the “OK” button will be in grey to prevent mis-operation. Apply the last default value to the tidal volume and the tidal volume should be set as 10 times of the body weight.

After you change the parameter on Setup Interface 1, the “Next Page” and “Back” buttons will be locked and you can only perform the mode transmission operation. If you need to cancel the change, you may press the “Setup” key.

Setup Interface 1 is as shown in the figure below (Setup Interface 1):

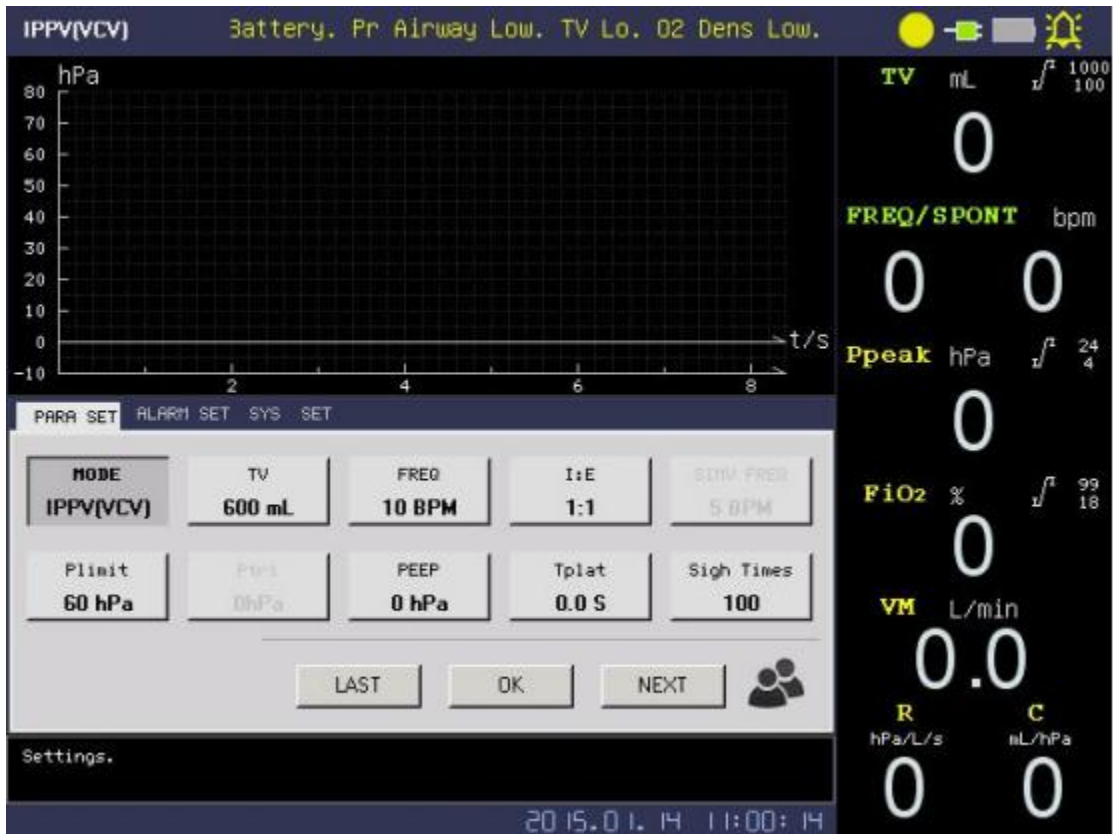

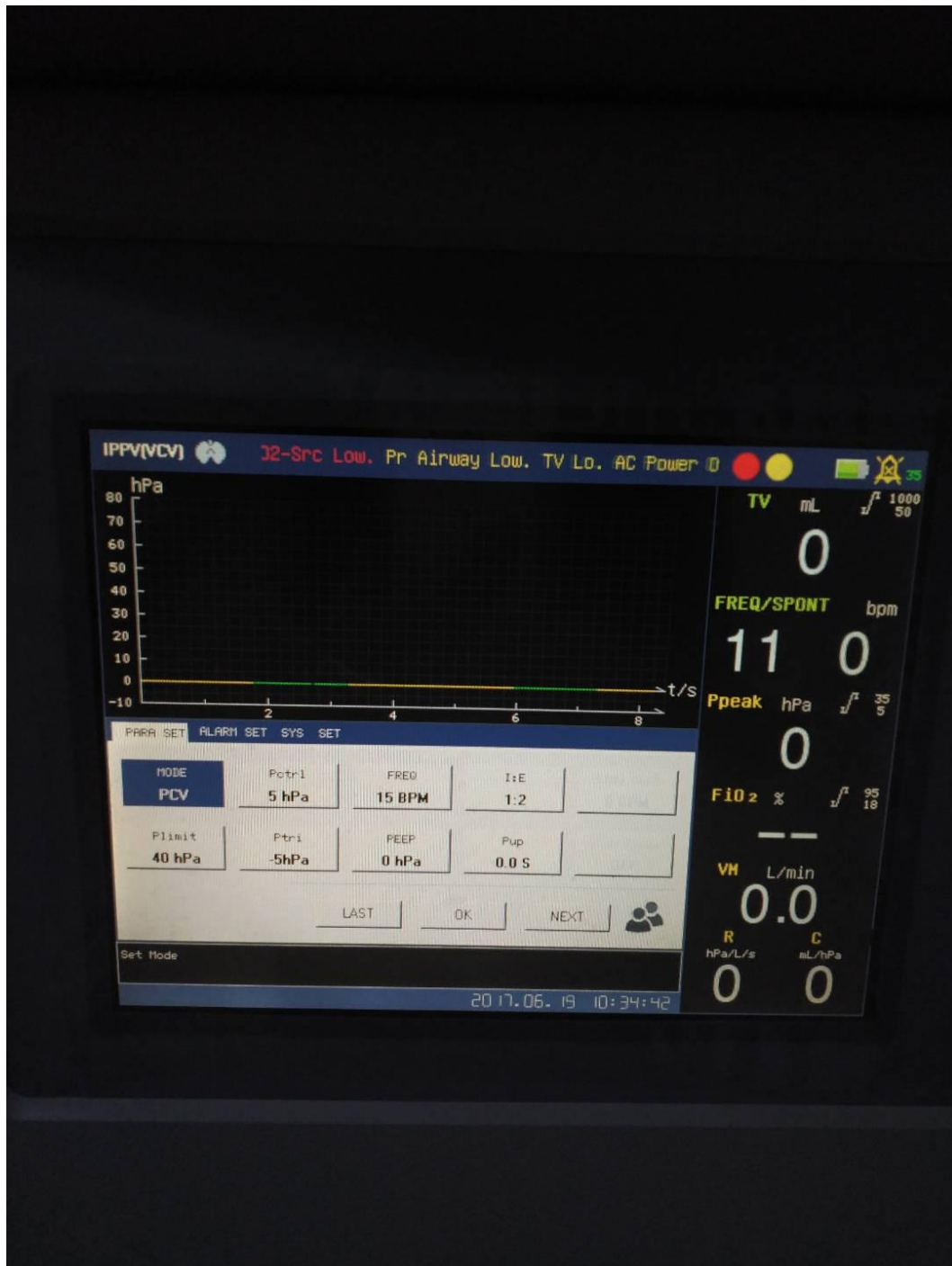

Figure 15

The parameters on Setup Interface 1 will be set in the following sequence:

Mode option: IPPV, SIPPV, VCV, PCV, IMV, SIMV, MANNUAL

Tidal Volume: 0~1500mL

Respiration Frequency: 0~100bpm

I/E Ratio: 8:1~1:10

SIMV frequency: 0~12bpm

Pressure limit range: 1~6 kPa

Ptr:-10~10 hPa;

Inspiratory Plateau:0~1S;

Sighs: this refers to the number of breaths for each deep breath and ranges from 70 to 150 breaths.

OFF indicates that sigh function is disabled; otherwise, it indicates that a deep breath will occur after the set breaths.

Setup Interface 2: press the “Next Page” button on Setup Interface 1 and the system will go to Setup Interface 2:

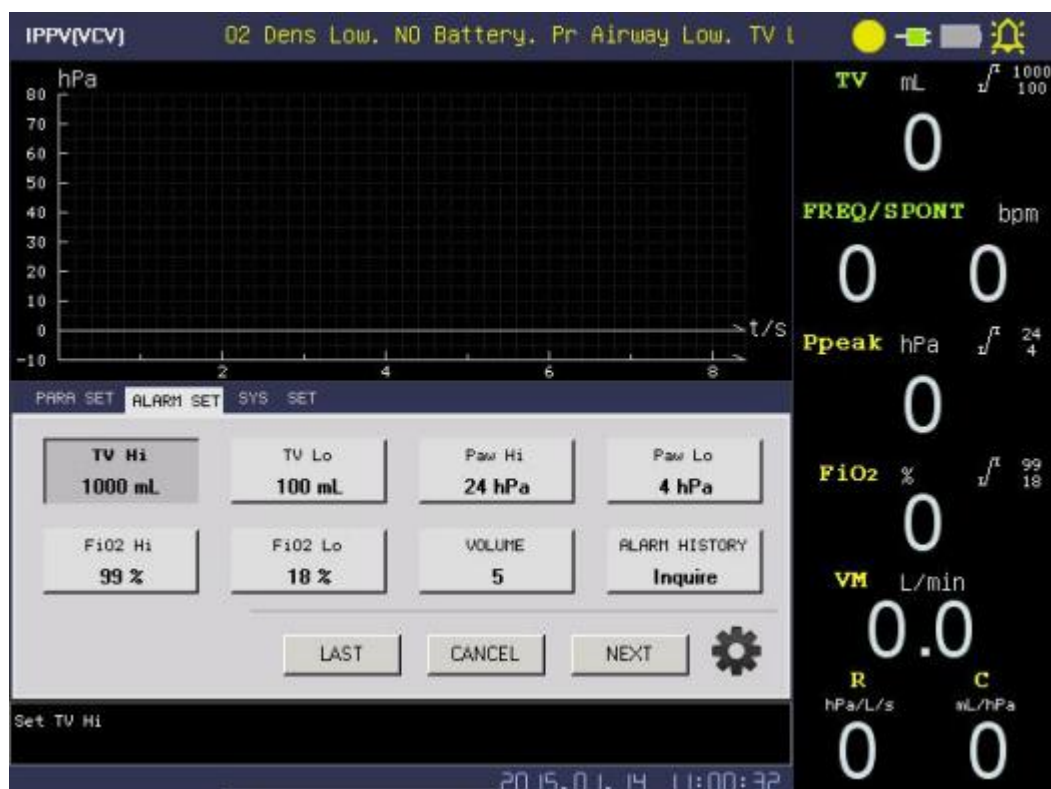

Figure 16

You can set the parameters in the following sequence on Setup Interface 2:

1. Tidal volume upper limit: 0.05—2.00 L.
2. Tidal volume lower limit: 0.05—1.80 L.
3. Peak pressure upper limit: 0—60 hpa.
4. Lower peak pressure limit: 2—50 hPa
5. Oxygen concentration upper limit: 21—100%.

6. Oxygen concentration lower limit: 10—80%.

7. Volume setting: 1-10.

8. Alarm history query: as shown in the figure above, after you press the “Alarm History” button, the detailed time when different alarms occur is shown and up to 100 alarms can be stored. The alarm can be shown in the format of “time->alarm description” and also high and medium level alarms can be displayed in red and yellow respectively.

Setup Interface 3: on Setup Interface 2, press the “Next Page” button or on Setup Interface 1 press the “Previous Page” button and the system will go to Setup Interface 3, as shown in the figure below (Setup Interface 3):

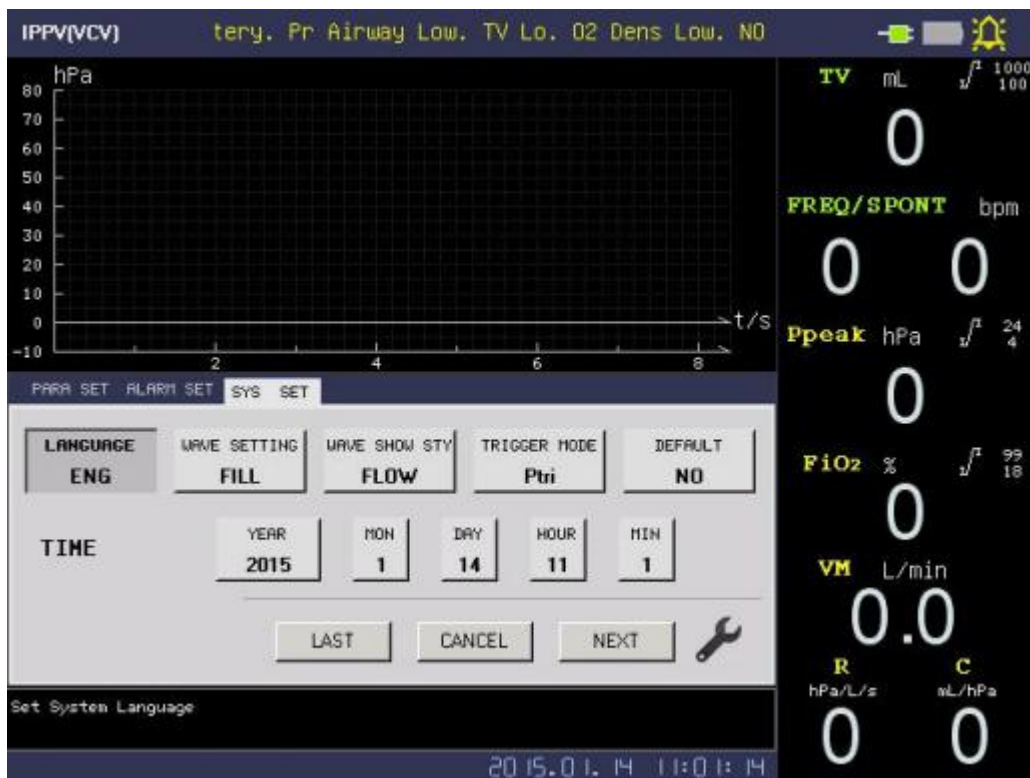

Figure 17

1. Language: Chinese and English

2. Waveform setting: overall setup of all waveform options is divided into 4 options:

Demonstration: this represents that the system operates in the demonstration mode.

Real-time: this represents that the system operates in the real-time mode.

Solid: this represents that the pressure-time and flow-time waveforms are represented in black solid curves.

Hollow: this represents that the pressure-time and flow-time waveforms are displayed in the hollow curve mode.

3. Waveform representation: flow/lung loop, flow: this represents the flow waveform displayed on the operating interface; lung loop: this represents the lung volume loop on the operating interface

4. Ptr: pressure triggering.

5. Factory defaults: recover to factory setting.

6. Time setting:

6.3.1.5 Key Instructions

Key Operations

On the panel of the anesthetic respirator, there are a total of 4 keys: “Manual”, “Set”, “Lung Loop” and “Silence”. Each key has the following function:

“Manual” : this key is for rapid operation and rapidly switching the ventilation mode of the respirator between IPPV and MAN.

“Set”: if you press this key, the setup interface will pop up and you can change the settings of all parameters.

“Lung Loop”: this key is for rapid operation and switching between the flow-time and lung function loop curves in the waveform area.

“Silence”: if an alarm occurs and an alarm sound is generated, you can silence the alarm for 120s by using the “Silence” key. During such period, if a new alarm occurs or you press this key again, you can immediately cancel the silencing function and recover the alarm sound.

6.3.2 SIPPV

SIPPV is the most common mode.

This mode is mainly intended for patients with no or weak and intermittent spontaneous breathing. If the patient shows no spontaneous breathing, the respirator provides

intermittent positive pressure ventilation of the patient following the set parameters, and this ventilation mode is namely called controlled ventilation mode. When the spontaneous breathing is recovered to a certain extent, the ventilation by the respirator is automatically synchronized with the spontaneous breathing in the patient, and this ventilation mode is namely called assisted ventilation mode. The control ventilation and assisted ventilation modes are switched to each other at an interval of 6s.

Operating parameters should be preset on the test lung following the procedures as follows:

- 1) Connect the gas source and power and confirm that the respirator operates in the “SIPPV” mode.
- 2) Adjust the “mechanical control frequency” and the corresponding data .
- 3) Select the I:E ratio according to the needs of the patient.
- 4) Adjust the “Adjust Tidal Volume” knob , observe the “Tidal Volume” indicator and set the tidal volume to the value as needed. For adult patients, make the initial setting based on the value of 10mL per kg of body weight and then fine tune the value according to the actual conditions of the patient.
- 5) The airway pressure indicator shows the variation in the airway pressure in real time. Carefully adjust the “Airway Pressure Limit” according to the airway pressure peak to set the airway pressure limit to a level slightly higher than the peak pressure.
- 6) Set the “Inspiration Triggering Pressure”. When the spontaneous breathing in the patient is recovered to a certain extent, the inspiration triggering pressure will provide a ventilation synchronization signal to the respirator. Generally, the inspiration triggering pressure can be set to be a level 0.1kPa lower than the minimum airway pressure when the patient has no spontaneous breathing.
- 7) Adjust the “PEEP” knob, observe the minimum airway pressure displayed when expiration ends and judge whether the setting of the PEEP is appropriate or not. The adjustment range is 0.15~1kPa.

Only upon completion of the above setting can you remove the test lung and connect the respirator with the patient.

After connecting the respirator with the airway in the patient, you should carefully observe the symptoms and lung inflation of the patient and further fine adjust the operation status of the respirator according to the monitor instrument and arterial blood and gas analysis data to achieve the optimal ventilation effect.

6.3.3 IPPV

This mode is only intended for patients with no spontaneous breathing.

Following the method in 6.3.2, have the respirator enter the IPPV mode. For the setting of the operating parameters in this mode, refer to 6.3.2.

In this mode, you can still (do not) select the PEEP and Sigh functions.

6.3.4 SIMV

This ventilation mode is intended for spontaneously breathing patients. It can gradually reduce the patient's dependency on the ventilator to facilitate weaning of the patient from the ventilator. In this mode, the mandatory ventilation of the patient is performed once at a certain interval. Upon completion of mandatory ventilation, the next mandatory ventilation is performed a certain period of time later. During the interval between two mandatory ventilations, the patient can spontaneously breath at his own breathing rate.

The interval at which the mandatory ventilation occurs depends on the setting of the "SIMV" frequency.

Have the respirator enter the SIMV mode following the method in 6.3.2.

Adjust the IPPV frequency, respiration rate, tidal volume, pressure limit, spontaneous inspiration triggering pressure, etc. to ensure that the optimal respiration indexes of the patient are reached.

You should adjust the "Inspiration Triggering Pressure" knob gradually from "0 kPa" to "-0.4kPa" to exercise and control the patient's spontaneous breathing efforts and respiratory volume. In this mode, the tidal volume should be adjusted in a finer mode because the tidal volume can change the patient's respiratory parameters under the impact by the inspiration triggering pressure such as the respiration time, respiratory rate, inspiratory tidal volume and other relevant life index.

You can still select (or may not) the PEEP and sigh functions in this mode.

6.3.5 AC and DC Operation

If AC power supply fails during the use of the anesthesia machine, the machine will automatically switch to the DC power supply and operate based on the originally set parameters. If DC power supply is also interrupted, the anesthetic respirator will stop gas supply and the anesthesia machine is switched to the Manual mode to provide fresh gas to the patient.

6.3.6 Pressure Maintenance

When the anesthesia system stops gas supply, the pressure of the medical gas pipeline will be maintained.

6.4 Shutdown Operation

Only when the operation is over, the patient recovers his spontaneous breathing and various life signs meet the shutdown requirements can the anesthesia machine be weaned. First remove the Tee tube connected with the patient and observe his spontaneous breathing. Only when his spontaneous breathing is completely recovered can the mask or duct be removed. Then:

- 1) Remove waste gas in the anesthetic recirculation circuit by using the rapid oxygen supply valve.
- 2) Close the oxygen and laughing gas cylinders remove the gas supply connector from the central gas supply system.
- 3) Open the oxygen flow valve and laughing gas flow valve, discharge the compressed gas in the anesthesia machine, and close the flow control valve when the indications on the oxygen pressure gauge and laughing gas pressure gauge reach the zero point.
- 4) Turn off the power switch and remove the power plug.
- 5) Remove, clean and disinfect those components needing to be done so.
- 6) Fill in the anesthesia machine service record.

7 Routine Maintenance

7.1 Cleaning

Wipe off the dust on the surface of the anesthesia machine by using a clean and soft cotton cloth dipped with cleaning agent or soap water. Then wipe it dry by using a soft dry cloth. During cleaning, never let any liquid enter the anesthesia machine (including the anesthetic respirator); otherwise, this will damage the machine and even cause electric leakage, short circuit, etc.

Remove thoroughly the accumulations on both sides of the filter screen and in the screen holes, wipe off the cloud-shaped accumulations on the internal wall of the soda lime can and observe whether the sealing ring and filtering sponge can continue to be used; if it cannot be ensured that they can be normally used, please replace with new ones promptly.

7.2 Cleaning and Disinfection

You can remove the components such as the respiratory tube, gas storage bag, inspiration valve, expiration valve, flow sensing impeller, etc in contact with the patient and put in clean water for washing and disinfect them. Remove dirt that may be attached to the internal wall of the circuit by using neutral cleaning agent. Take special care to clear sputum scab, bloodstain, oil stain and other dirt residues in the tube. Then wipe and wash them clean by using clean water. Soak components in contact with the patient in medical alcohol with a concentration of 70% for 1 hour and disinfect them after air dry them.

Disinfection Method I: soak the cleanly washed respiratory tube and mask in the disinfectant for 30 to 60min (pay attention to that latex products will be easily damaged if soaked for too long time). Common disinfectants include Bromogeramine solution, peracetic acid, 84 disinfectant, etc. Flush the circuit to remove the disinfectant by using the sterilizing saline or distilled water and suspend the circuit to air dry it.

Disinfection Method II: disinfect the cleanly washed respiration tube and mask in the ethylene oxide disinfection box.

If the patient is a patient with transmitted disease, soak the cleaned and disinfected components in 70% medical alcohol for 1.5 hours and then repeat the above mentioned

disinfection treatment.

Attention: remove and wash off the waste water, waste fluid and dirt generated by the anesthesia machine which may transmit diseases and contaminate the environment. Dispose of them in accordance with relevant national specifications and requirements.

7.3 Routine Maintenance

The cleaned and disinfected anesthesia machine components should be replaced to the anesthesia machine promptly and the basic performances of the anesthesia machine should be checked and tested following the instructions in Chapter 4 “Installation and Commissioning” of this manual to ensure that all functions of the machine are sound.

7.4 Maintenance of Filtering Component

Operator should make sure to clean and replace the sponge cushion at the air inlet in the rear part of the anesthesia machine. You can directly screw off it and wash by using hands. It should be preferentially replaced when it has been used ten times.

8 Troubleshooting

Symptom	Possible Cause	Solution
Respiratory tidal volume is not stable or displayed	Inspiration triggering pressure is not properly set	Re-adjust the inspiration triggering pressure to the correct level
	Flow sensor is damaged	Replace the flow sensor
Respirator does not operate normally	The Manual/Maneuvering changeover switch mode does not match the operating mode of the respirator.	Adjust the Manual/Maneuvering changeover switch mode to match the operating mode of the respirator
Indication from the oxygen pressure gauge or laughing pressure gauge is incorrect	Gas source pressure into the anesthesia machine is too low	Adjust the pressure of the gas source
	The anesthesia machine tube leaks gas	Check the gas tube connector and replace the leaking duct.
	The pressure regulator valve is in malfunction.	Re-adjust or replace the pressure regulator valve

Vaporizer can concentration is inaccurate	The output concentration of vaporizer can is too low or the flow meter flow value is set to a too low level.	Set the output concentration or flow meter to the correct range.
	The vaporizer can output concentration is high	The vaporizer can concentration is too high or higher than the upper dosing limit.
Vaporizer can leaks agent	The dosing knob is not tightly closed.	Tighten the dosing knob
	Drug discharging screw is not tightly tightened	Tighten the drug discharging screw.
The machine operating frequency is too fast	The frequency setting is too high or the inspiration triggering pressure is inappropriately set	Adjust the operating frequency to the correct level and set the inspiration triggering pressure to be negative
Ventilation volume alarm	The tidal volume setting is too low or the ventilation volume lower limit is set to be too high.	Set the tidal volume and ventilation volume to be within a correct operating range.
The anesthesia machine airway pressure alarm and airway pressure limits icons are highlighted and the upper airway pressure limit alarm continues to be on	The tidal volume and I:E ratio are not properly adjusted.	Adjust the I:E ratio and tidal volume
	The upper pressure limit is not appropriately set	Adjust the upper pressure limit
	The patient's spontaneous breathing conflicts with the mechanical ventilation	Re-adjust the correct synchronization triggering value.

	The patient suffers tracheospasm or airway resistance is increased by secretions	Sputum suction of the patient is recommended and expectorant should be used
The anesthetic respirator airway pressure alarm icon is highlighted and the airway pressure lower limit alarm continues to be on.	The tidal volume value is set to be too small.	Adjust the tidal volume
	The pressure of the oxygen cylinder or central oxygen supply is insufficient	Adjust the gas source pressure to the value required by the anesthesia machine
	The oxygen cylinder reducer or oxygen conveyance circuit is in malfunction	Replace the oxygen reducer and test and re-install the oxygen conveyance circuit.
	AC power supply voltage is too low	Ensure AC power supply voltage for the operation of the battery.
	Battery power is insufficient after AC power supply is down	Replace with battery with sufficient capacity
Continuous audible alarm	The battery power is exhausted or battery is damaged after the AC power supply is down.	Replace with battery with sufficient capacity
Flow meter cannot be opened	Flow meter input circuit is bent or knob slides	Check and reconnect the flow meter input circuit and tighten the knob and fix the screws.
Flow meter cannot be closed	Flow bolts are too tight or knob slides	Tighten the knob fixing screws or replace with new ones

Rapid oxygen supply valve does not provide gas	The spring of the rapid oxygen supply valve is snapped and the seal ring is dry or valve contains sundries.	Adjust or replace spring and apply Vaseline to the seal ring and clear sundries.
Rapid oxygen supply valve outputs gas all the time	Seal ring is aged or rapid oxygen supply valve cannot retract after being pressed	Re-adjust, install or replace it
Battery works while power grid power supply is normal.	AC power plug is not properly connected.	Connect the power plug.
	Fuse is melted.	Replace the fuse
	Wire block or power wire is damaged	Replace the wire block or power wire

9 Safety and Accident Handling

- 1) To prevent incorrect connection of input oxygen and laughing gas into the anesthesia machine, different connectors are used. The cylinder reducer valve is marked in different colors: blue for oxygen and grey for laughing gas.
- 2) Internal pipeline gas color differentiation: oxygen tube is in blue, laughing gas tube is in orange and mixed gas tube is in light blue or transparent tube.
- 3) The vaporizer should be loaded with anesthetic agent to a level which should never be beyond the upper limit scale line on the observation window.
- 4) The vaporizer should not be inclined by more than 45 DEG. The concentration adjustment disk must not be adjusted until the zero point locking switch is pressed. Excessive pressure should not be forcedly applied to the vaporizer; otherwise, internal parts will be damaged. You must not dismantle or disassemble the vaporizer. It has been sophisticatedly tested before leaving factory. You must not disinfect it but only can blow it dry with medical compressed oxygen. IN case of any problem, mail it to the manufacturer for repair.
- 5) Prior to transportation of the anesthesia machine, the vaporizer must be removed from the machine and separately packaged. Prior to packaging, the vaporizer must be thoroughly cleared of the anesthetic agent and blown dry by using medical compressed oxygen.

6) To prevent oxidation burning caused by pure oxygen, never place the oxygen pressure gauge and oxygen flow regulator valve close to the oil and grease.

7) This machine should be securely grounded for protection to ensure personal safety.

8) The oxygen concentration in the atmosphere must not exceed 24%.

9) The driving gas for the anesthetic respirator has nothing to do with the compositions of the respiratory gas in the patient, so the oxygen flow switch of the anesthesia machine must be turned on during the use of the anesthetic respirator to provide continuously the oxygen at appropriate flow rate and thus avoid the accident of oxygen deficit.

10) If the respiratory bag cannot be completely compressed when the patient inspires, then this will cause the tidal volume provided to the patient to be insufficient. You should immediately check the airway for smoothness and increase the driving pressure as appropriate, that is, you should rotate the tidal volume control knob to the increasing direction and reduce the compensation for the oxygen flow rate. If the respiratory bag cannot recover to the starting status during the respiration by the patient, then this indicates that the respiratory circuit leaks a great amount of gas and you should check and correct the leak in time, and increase the compensation for oxygen flow rate as appropriate to ensure sufficient ventilation volume.

11) The battery should be charged after being used. It should be charged at an interval no longer than 12h. The charging current must comply with the requirements of the Instructions for Use of the battery. When not in use, it should be ensured that it is charged once every month to ensure that the battery can provide sufficient power when being used. During replacement, special care should be taken not to incorrectly connect the battery electrodes—red wire for positive electrode and blue wire for negative electrode. Electrode wires must be connected securely to avoid open circuit, heating, flame, etc. The battery must be kept vertical during transportation, storage and use. Keep it top down or in horizontal position is strictly prohibited. Avoid intensive vibration.

12) The anesthetic respirator uses $\Phi 5 \times 20$ mm 0.5A glass T-shaped slowly operating fuse tube. Prior to replacement of the fuse, power should be cut off and then the fuse box should be opened by using tools. Upon completion of replacement, install the fuse box by using tools.

10 Packaging, Transportation and Storage

10.1 Packaging

The anesthesia machine packaging box should comply with the requirement of GB / T 15464 . Each anesthesia machine must be securely positioned in the packaging box. Between the packaging box and product, soft material with appropriate thickness should be provided to prevent loosening and mutual friction during transportation. The packaging box should be provided with moisture protection and rain protection to ensure that product is protected from natural damage.

10.2 Transportation

The original packaging box and vibration proof cushion should be used according to provisions.

Standardize the transportation based on the indications and symbols on the packaging box. These indications and symbols are:

-----Fragile items;

-----Up

-----Keep dry

The packaging box must be protected by cover in case of open air transportation to protect from sunlight and rain wetting or intensive vibration. It is strictly prohibited to keep top down and throw it.

10.3 Storage

-----Ambient temperature: $-15^{\circ}\text{C} \sim +50^{\circ}\text{C}$

-----Relative humidity: no higher than 90 %

-----Atmospheric pressure: 86 kPa \sim 106 kPa.

-----It should be stored in a room without corrosive gas and well ventilated.

11 Others

In addition to the essential cleaning, disinfection and routine maintenance upon completion of each use, the anesthetic recirculation circuit of the anesthesia machine needs to be disassembled and cleared of the water and soda lime powder every month.

The anesthetic respirator should be thoroughly disinfected and maintained once every twelve months.

The vaporizer should be tested and checked once every twelve months.

The flow sensor should be tested and checked once every other year.

Maintenance and repair should be performed by specially appointed persons and recorded for archiving for consultation for future maintenance and repair.

If the machine is not used for more than six months, you must thoroughly perform the performance test on it before restarting it.

The troubleshooting methods provided in this manual are the basic methods for solving the faults of the anesthesia machine. If the faults cannot be eliminated by using these methods or faults repeatedly occur, then this should be notified to the manufacturer and authorized service maintenance organization.

If the user needs to get more detailed information about the product, he may contact by emailing us and we will provide the corresponding information according to the specific conditions.

